

# Clarke®

## WOODWORKER



### VACUUM EXTRACTOR

MODEL NO: CWVE1

PART NO: 6471168

### OPERATING & MAINTENANCE INSTRUCTIONS



GC0916

---

## INTRODUCTION

---

Thank you for purchasing this CLARKE Workshop Vacuum Extractor.

Before attempting to use this product, please read this manual thoroughly and follow the instructions carefully. In doing so you will ensure the safety of yourself and that of others around you, and you can look forward to your purchase giving you long and satisfactory service.

## PRODUCT SPECIFICATIONS

Model Number	CWVE1
Dimensions (Length x Width x Height)	377 x 355 x 660 mm
Weight	10.7 kg (empty)
Container Capacity	50 Litres
Max Vacuum	2.500 Pa
Hose Length/Dia	L = 2000 (extended) / Dia = 100 mm
Airflow	3.05 m <sup>3</sup> /min (183m <sup>3</sup> /hr)
Duty Cycle	S1 (continuous)
Input Power	1100W
Motor Speed	20000 rpm
Power Supply	230V @ 50Hz 1ph
IP Rating	IP20
Measured Sound Pressure Level	80 LWA dB(A)
Uncertainty Factor	1.5

---

## GENERAL SAFETY PRECAUTIONS

---

### WORK AREA AND PERSONAL SAFETY

1. Avoid operating in the presence of flammable liquids or gases. The motor may produce sparks during operation. Do not use in enclosed areas where flammable, explosive or toxic vapours are given off.

2. Always stay alert, watch what you are doing and use common sense when operating the dust extractor. Do not use while you are tired or under the influence of medication, drugs or alcohol. Lack of attention can result in personal injury.
3. Never over-reach. Keep your proper footing and balance at all times to enable better control of the dust extractor in unexpected situations.
4. Never use a power product if any part is damaged. Have it inspected and repaired by your Clarke dealer. Do not use if the electric cable, plug, or the machine itself, is in poor condition.
5. Do not insert fingers or other objects into the inlet opening.
6. Always wear eye and ear protection when using the extractor.

## **GENERAL PRODUCT USE AND CARE**

1. Prior to use, all users should become familiar with the warnings in this instruction manual.
2. Always maintain the dust extractor with care and keep it clean for best/ safest performance.
3. Never abuse the power cable. Never pull on the cable when removing the plug from the socket or lift the extractor by the power cable. Take care not to close doors on the cable or allow it to become snagged under objects with sharp edges. Keep away from heat or oil.
4. Only use extension leads that are of an appropriate power rating and suitable for the work environment. Extension leads must have an earth connection. Inspect the extension lead regularly and replace if damaged.
5. Never abuse the dust extractor by standing on it.
6. Always store the dust extractor out of reach of children.

## **DUST EXTRACTOR SAFETY INSTRUCTIONS**







1. This dust extractor is for indoor use only.
2. This dust extractor is for collecting wood chips, shavings and dust particles only. Do not use with hazardous substances i.e. MDF dust.
3. Always ensure that the dust extractor is properly positioned where necessary to prevent it from moving during use and that the immediate area is kept clear.
4. Always use a face or dust mask if operation is particularly dusty including when disposing of the contents.
5. Always disconnect the dust extractor from the power supply before servicing or removing & emptying the filter bag etc.

6. Never leave the dust extractor running unattended. Turn power off and wait for the machine to stop before leaving.
7. Do not use in enclosed areas where flammable, explosive or toxic vapours are given off, by oil based paints, paint thinner, petrol etc.
8. Never pick up flammable or readily combustible material, including burning cigarettes or other smoking substances.
9. Never attempt to pick up liquids with this vacuum extractor.
10. Always use in an upright position. Always transport the dust extractor using the handle.
11. Always take care when a long hose is required in the work area as it presents a trip hazard. Tidy the hose away when the job is finished.
12. Do not use without the inlet hose attached and ensure the cover is securely in place when in operation.
13. Only use parts and accessories recommended in this manual. The use of unauthorised accessories or attachments is not permitted and may result in personal injury or damage to the dust extractor.
14. Do not attempt to repair or modify the dust extractor or attempt any electrical repair yourself. Consult a qualified electrician or the Clarke Service Department on 020 8988 7400.

---

## SAFETY SYMBOLS

---

	Read instruction manual before use		Wear dust mask
	Weee Directive		Wear ear defenders
	Indoor Use Only		Wear safety glasses

The above safety symbols appear on the product.

## ELECTRICAL CONNECTIONS



**WARNING! READ THESE ELECTRICAL SAFETY INSTRUCTIONS THOROUGHLY BEFORE CONNECTING THE PRODUCT TO THE MAINS SUPPLY.**

Before switching the product on, make sure that the voltage of your electricity supply is the same as that indicated on the rating plate. This product is designed to operate on 230VAC 50Hz. Connecting it to any other power source may cause damage.

This product may be fitted with a non-rewireable plug. If it is necessary to change the fuse in the plug, the fuse cover must be refitted. If the fuse cover becomes lost or damaged, the plug must not be used until a suitable replacement is obtained.

If the plug has to be changed because it is not suitable for your socket, or due to damage, it should be cut off and a replacement fitted, following the wiring instructions shown below. The old plug must be disposed of safely, as insertion into a mains socket could cause an electrical hazard.



**WARNING! THE WIRES IN THE POWER CABLE OF THIS PRODUCT ARE COLOURED IN ACCORDANCE WITH THE FOLLOWING CODE: BLUE = NEUTRAL BROWN = LIVE YELLOW AND GREEN = EARTH**

If the colours of the wires in the power cable of this product do not correspond with the markings on the terminals of your plug, proceed as follows.

- The wire which is coloured **Blue** must be connected to the terminal which is marked **N** or **coloured black**.
- The wire which is coloured **Brown** must be connected to the terminal which is marked **L** or coloured red
- The wire which is coloured **Yellow and Green** must be connected to the terminal which is marked **E** or  or coloured **Green**.

**Plug must be BS1363/A approved.**

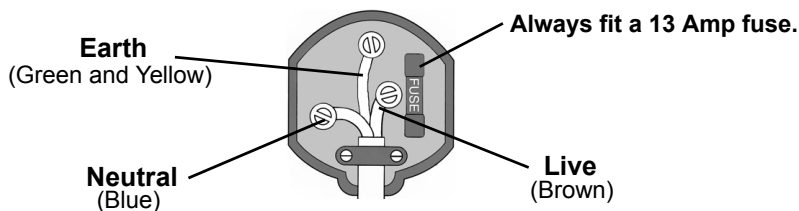

**Ensure that the outer sheath of the cable is firmly held by the clamp**

We strongly recommend that this machine is connected to the mains supply via a Residual Current Device (RCD). If in any doubt, consult a qualified electrician. **DO NOT** attempt any repairs yourself.

# COMPONENTS

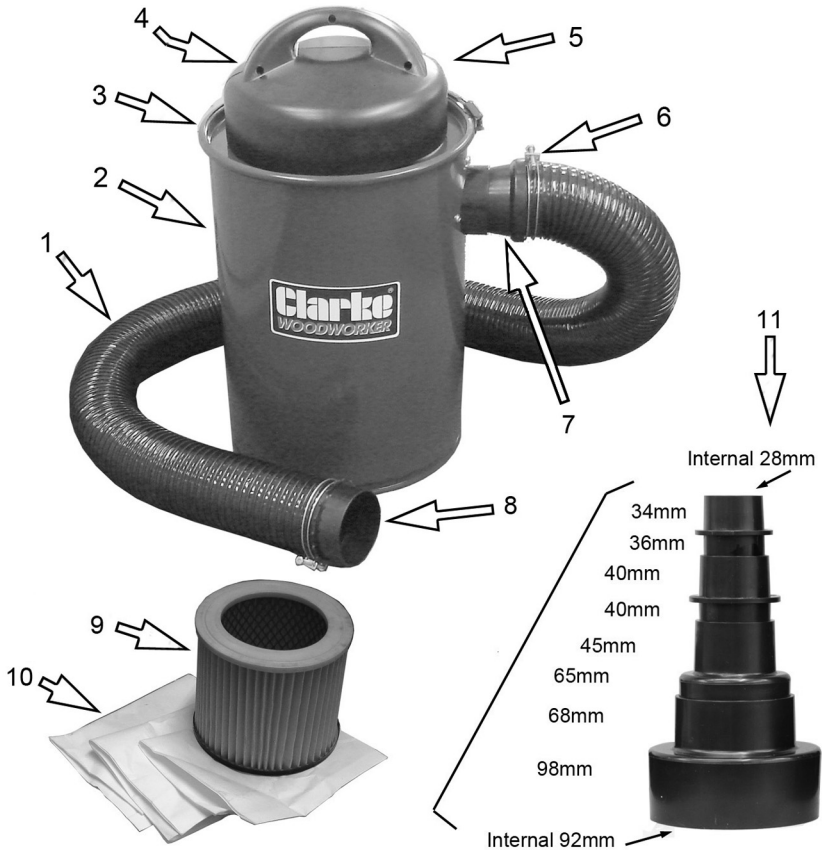

When unpacking please check contents and advise your dealer immediately if any parts are missing. The essential components are as follows;

Pos	Description
1	Inlet Hose
2	Dust Container
3	Retaining Band
4	On/OFF Switch
5	Motor Casing
6	Hose Clamps (x2)

Pos	Description
7	Tapered Hose Connector
8	Straight Hose Connector
9	Filter Cartridge
10	Filter Bags
11	Inlet Adaptor Set (dims shown)

## ASSEMBLY

1. Place filter cartridge (1) into a filter bag (2) as in Fig 1.

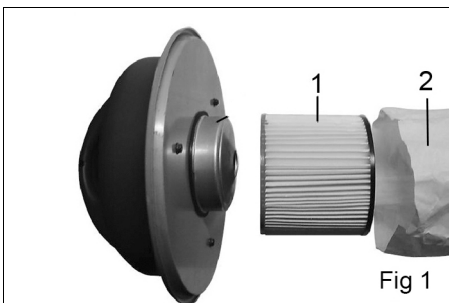

2. Fold any overhang into the filter cartridge.

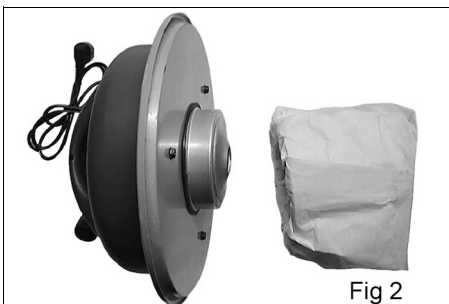

3. Push the filter cartridge (1) complete with bag (2), onto the fan housing part of the motor casing (3).
4. Sit the entire motor casing on the container and secure with the retaining band as shown on page 6 (item 3).

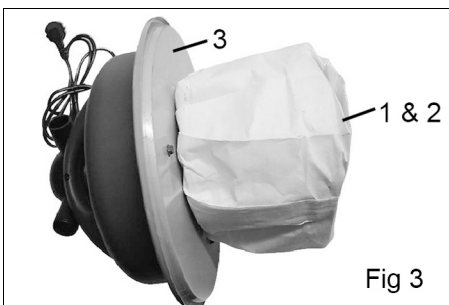

5. Attach the inlet hose to the tapered hose connector using one hose clamp as shown in Fig 4.
6. Push-fit the hose connector to the dust collector body.



7. Secure the other end of the inlet hose to the straight hose connector using the remaining hose clamp as shown in Fig 5.
- The inlet adaptors can then be connected to the straight hose connector as required to suit the size of the extract duct on the woodworking appliance to be used.

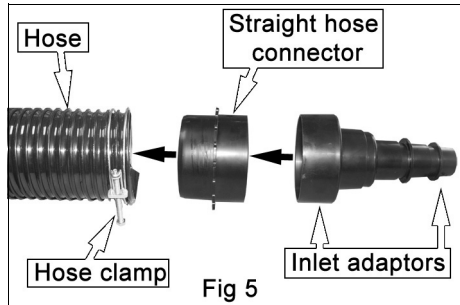

8. Before plugging into the power supply, the extractor should be positioned on a firm, level surface. Do not cover the dust extractor and always position it with good all-round air ventilation. The dust extractor must remain upright.

---

## OPERATING AND MAINTENANCE

---

Regularly inspect the filter for damage before use and replace if necessary.

Regularly check the tightness of the filter, filter bag and retaining band.

Check the power cable to ensure it is free from cracks, bare wires etc.

Connect the inlet hose to the outlet on your woodworking appliance using the inlet adaptor(s). Start the extractor using the ON/OFF switch (I=on/O=off).

Take care not to suck in foreign objects such as screws, nails, large pieces of plastic or wood.

Empty the dust extractor after use and clean it when required. Dislodge as much imbedded debris as possible from the filter. Refit the filter over the motor inlet.

Ensure the hose is kept in good condition. A damaged hose will seriously effect the efficiency of the dust extractor and should be replaced. Contact your CLARKE dealer for replacements.

## CARE & STORAGE

1. When not in use, switch off and unplug from the power supply and ensure the power cable is not left as a hazard for persons to trip over.
2. With the dust extractor unplugged from the power supply, use a dry cloth to wipe over the casing. Do not use solvents, thinners or alcohol to clean the dust extractor, as these chemicals will damage the finish.
3. Store the dust extractor in a secure, dry place, out of the reach of children. DO NOT leave it exposed to the elements and avoid direct sunlight, direct heat, rain/moisture etc.



# TROUBLESHOOTING

Problem	Possible cause	Suggested Remedy
Motor will not run	Defective switch, cable or motor.	Check electrical connections to all components or consult your Clarke dealer.
Excessive dust in the air	Loose retaining band or hose. Collecting bag damaged.	Tighten connections. Replace collecting bag.
Unexpected noise from fan/motor	Loose internal components. Dust buildup inside housing.	Consult your Clarke dealer.
Machine runs but fails to reach full speed.	Low voltage or motor defective.	Have machine repaired by your Clarke dealer
Motor fails to develop full power.	Supply circuit overloaded. Extension lead unsuitable.	Use different circuit. Replace extension lead.

## ENVIRONMENTAL RECYCLING POLICY



Through purchase of this product, the customer is taking on the obligation to deal with the WEEE in accordance with the WEEE regulations in relation to the treatment, recycling & recovery and environmentally sound disposal of the WEEE.

In effect, this means that this product must not be disposed of with general household waste. It must be disposed of according to the laws governing Waste Electrical and Electronic Equipment (WEEE) at a recognised disposal facility.

## GUARANTEE

This product is guaranteed against faulty manufacture for a period of 12 months from the date of purchase. Please keep your receipt which will be required as proof of purchase.

This guarantee is invalid if the product is found to have been abused or tampered with in any way, or not used for the purpose for which it was intended.

Faulty goods should be returned to their place of purchase, no product can be returned to us without prior permission. This guarantee does not effect your statutory rights.

# PARTS DIAGRAM

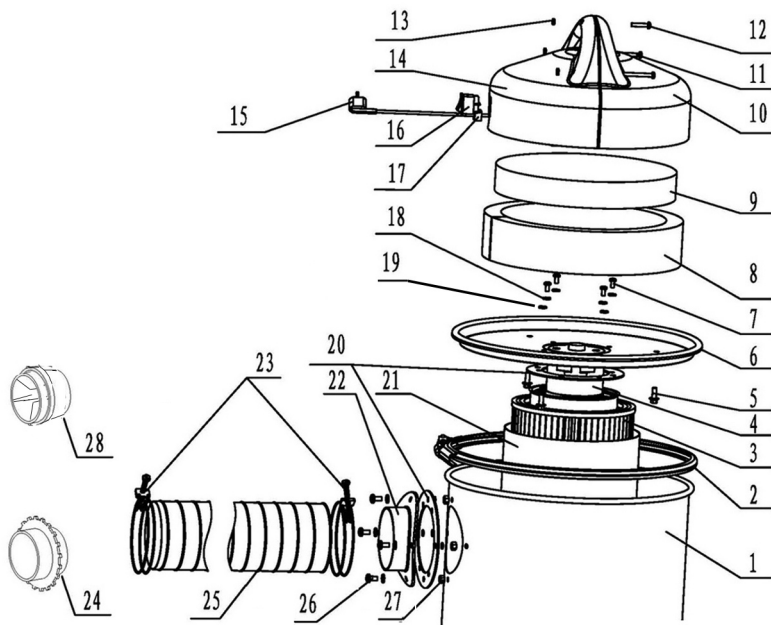

Pos No	Description
1	Container
2	Retaining Band
3	Cartridge Filter
4	Motor Assembly
5	Screw 5.5 x 15
6	Container Lid
7	Screw 5.5 x 15
8	Outer Sponge Belt
9	Sponge Pad
10	R/H Motor casing
11	Screw M5 x 45
12	Screw M5 x 25
13	M5 Nut
14	L/H Motor Casing

Pos No	Description
15	Power Cable with Plug
16	On/Off Switch
17	Cable Gland
18	Spring Washer 5mm
19	Washer 5mm
20	Rubber Seal
21	Filter Bag
22	Hose Connector
23	Hose Clamps
24	Hose/Adaptor Connector
25	Inlet Hose
26	Screw M5 x 12
27	Nut M5
28	Hose/Container Connector

# DECLARATION OF CONFORMITY



**Clarke**<sup>®</sup>  
**INTERNATIONAL**

Hemnoll Street, Epping, Essex CM16 4LG

## DECLARATION OF CONFORMITY

This is an important document and should be retained.

We hereby declare that this product(s) complies with the following directive(s):

2014/30/EU *Electromagnetic Compatibility Directive.*

2006/42/EC *Machinery Directive.*

2011/65/EU *Restriction of Hazardous substances.*

The following standards have been applied to the product(s):

*EN 60335-2-69:2012, EN 60335-1:2012, EN 62233:2008, EN 55014-1:2006 +A2:2011,*

*EN 55014-2:2015, EN 61000-3-2:2006 +A2:2009, EN 61000-3-3:2013.*

The technical documentation required to demonstrate that the product(s) meet(s) the requirement(s) of the aforementioned directive(s) has been compiled and is available for inspection by the relevant enforcement authorities.

The CE mark was first applied in: 2014

**Product Description:** Workshop vacuum extractor  
**Model number(s):** CWVE1  
**Serial / batch Number:** N/A  
**Date of Issue:** 14/07/2016

Signed:

**J.A. Clarke**  
Director

# A SELECTION FROM THE VAST RANGE OF

# Clarke®

## QUALITY PRODUCTS

### AIR COMPRESSORS

From DIY to industrial, Plus air tools, spray guns and accessories.

### GENERATORS

Prime duty or emergency standby for business, home and leisure.

### POWER WASHERS

Hot and cold, electric and engine driven - we have what you need

### WELDERS

Mig, Arc, Tig and Spot. From DIY to auto/industrial.

### METALWORKING

Drills, grinders and saws for DIY and professional use.

### WOODWORKING

Saws, sanders, lathes, mortisers and dust extraction.

### HYDRAULICS

Cranes, body repair kits, transmission jacks for all types of workshop use.

### WATER PUMPS

Submersible, electric and engine driven for DIY, agriculture and industry.

### POWERTOOLS

Angle grinders, cordless drill sets, saws and sanders.

### STARTERS/CHARGERS

All sizes for car and commercial use.



**PARTS & SERVICE: 0208 988 7400**

**E-mail: [Parts@clarkeinternational.com](mailto:Parts@clarkeinternational.com) or [Service@clarkeinternational.com](mailto:Service@clarkeinternational.com)**

**SALES: UK 01992 565333 or Export 00 44 (0)1992 565335**

**Clarke® INTERNATIONAL** Hemnall Street, Epping, Essex CM16 4LG  
[www.clarkeinternational.com](http://www.clarkeinternational.com)